

Compact pressure switch for gases and air GW A4

Pressure limiters
ÜB A4 and NB A4
Double pressure switches
GW A4/ GW A4

DUNGS®

5.02



Technical description

The GW A4 pressure switches, the pressure limiters ÜB A4 and NB A4 and the double pressure switch GW A4 / GW A4 are adjustable pressure switches for automatic burner controls. They are suitable for switching a circuit on, off or over on changes in actual pressure value relative to the set reference value.

The reference value (switching point) is adjusted on a setting wheel provided with a scale. Test nipple integrated in metal housing as standard.

Application

Pressure monitoring in firing, ventilation and air-conditioning systems. Suitable for gases of families 1,2,3 and other neutral gaseous media.

Approvals

EU type test approval as per EU Gas Appliance Directive. TÜV (German Technical Inspectorate) inspection for pressure switches of special construction as per TRD 604 and VdTÜV Technical Data Sheet, edition 100/1, as well as Class "S" as per EN 1854.

GW...A4	CE-0085 AO 0012
ÜB...A4	CE-0085 AO 0026
NB...A4	CE-0085 AO 0039

Approvals in other important gas-consuming countries. Special designs for the North American market with U_L, FM and CSA registrations.

Functional description

Single-acting pressure switch or pressure limiter in pressure range. The pressure switches and/or pressure limiters work without using any auxiliary power.

GW A4 pressure switch

The control unit responds to pressure. If the set reference value is exceeded or undershot, the circuit is switched on, off or over.

ÜB A4, NB A4 pressure limiters

The control unit responds to pressure. Interlock is performed when the set reference value is exceeded or undershot.

The "Locked" switching state is indicated by a glow lamp.

Restart is only possible by activating the reset button on the setting wheel of the pressure limiter after the operating pressure is attained.

ÜB A4: Switches and locks when the set pressure is exceeded.

NB A4: Switches and locks when the set pressure is undershot.

Double pressure switch

GW A4 / GW A4

Combination of two GW A4 single pressure switches flanged together. The setting of the two reference values is performed separately and independently. This permits a combination of different reference value setting ranges. The same medium and pressure are applied to the two control units.

GW A4 switching function

As pressure rises:

1 NC opens, 2 NO closes

As pressure falls:

1 NC closes, 2 NO opens

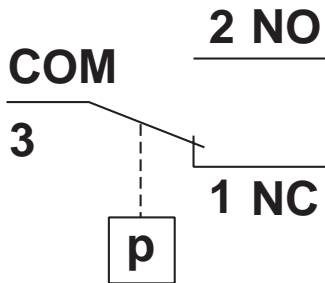

ÜB A4 switching function

As pressure rises

2 NO closes, 1 NC opens

Glow lamp ON, locked.

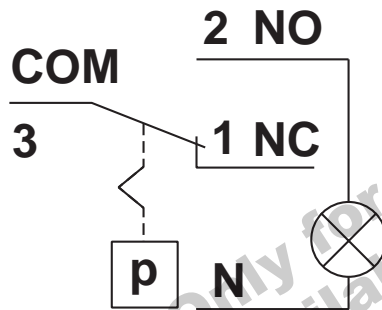

NB A4 switching function

As pressure falls

2 NO opens, 1 NC closes

Glow lamp ON, locked.

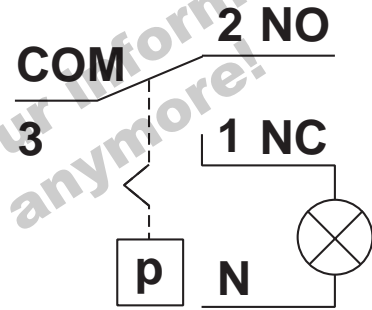

Operating state

Definition of switching difference Δp

The switching difference Δp is the pressure difference between the upper and lower switching pressures

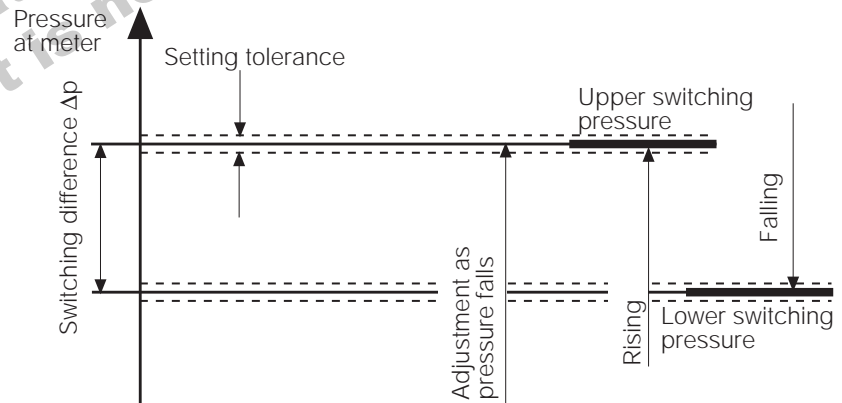

Specifications

Max. operating pressure	NB, ÜB, GW 3 A4 - GW 150 A4 NB, ÜB, GW 500 A4	500 mbar (50 kPa) 600 mbar (60 kPa)
Pressure connection	Standard: Special design:	G 1/4 female thread on centre of housing underside as per ISO 228 additionally G 1/4 female thread on opposite measuring connection side
Measuring connection	Test nipple integrated in metal housing, \varnothing 9	
Temperature range	Ambient temperature Medium temperature Storage temperature	-15 °C to +60 °C -15 °C to +60 °C -30 °C to +80 °C
Materials	Housing Switch Diaphragms Switching contact	aluminium die casting polycarbonate NBR basis Ag, fine silver, optional (Au)
Switching voltage	AC eff. min. 10 V DC min. 12 V	max. 250 V max. 48 V
Nominal current	AC eff. 10 A	
Switching current	AC eff. 6 A AC eff. 3 A AC eff. min. 20 mA DC min. 20 mA DC max. 1 A	at $\cos \varphi$ 1 at $\cos \varphi$ 0,6
Electrical connection	Standard: Special design:	at screw terminals via PG* 11 cable gland (* heavy-gauge conduit thread) plug connection for line sockets as per DIN 43 650 A, 3-pin with protective contact
Degree of protection	IP 54 as per IEC 529 (EN 60529)	
Setting tolerance	\pm 15% switching point deviation referred to reference value, adjusted as pressure rises, vertical diaphragm position	

Dimensions [mm]

GW ... A4, ÜB ... A4, NB ... A4

GW ... A4 / GW ... A4

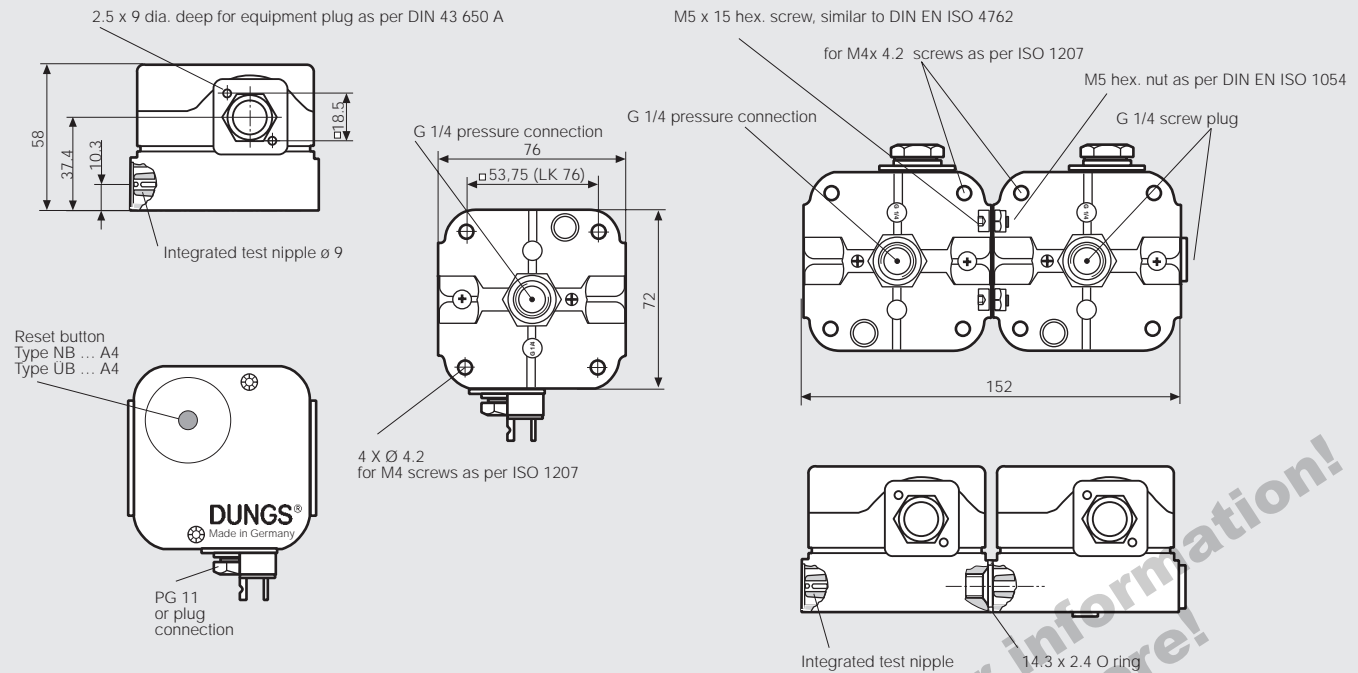

Installation position

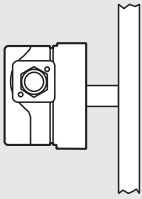

Standard installation position

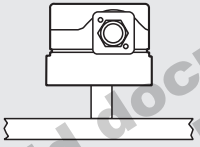

When installed horizontally, the pressure switch switches at a pressure higher by approx. 0.5 mbar.

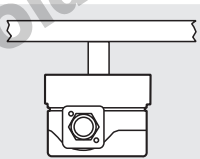

When installed horizontally overhead, the pressure switch switches at a pressure lower by approx. 0.5 mbar.

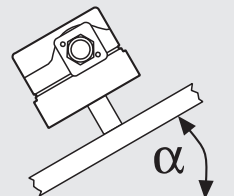

When installed in an intermediate installation position, the pressure switch switches at pressure deviating from the set reference value by max. ± 0.5 mbar.

Designation

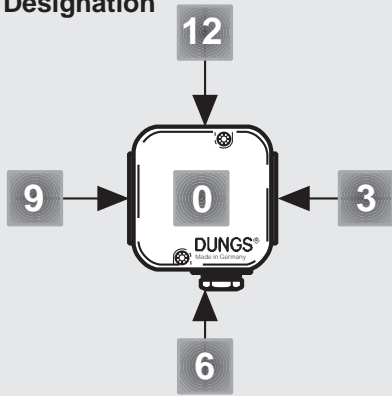

Order example

Pressure switch design

ÜB pressure limiter

Setting range

30 - 150 mbar

Contact material

Ag fine silver (standard)

Electrical connection

PG screw union

Test nipple

MS 9

Screw plug

At position 0

Pressure connection

G 1/4 at position 3

ÜB 150 A4 [AG-PG-MS9-VS0-V3]

GW 50 A4 [AG-PG-MS9-V0]



Accessories for pressure switches GW A4, NB A4, ÜB A4

Order No.

Kit: G3 equipment plug, 3-pin + E, GW...A	219 659
Kit: G3 equipment plug, 3-pin + E, NB.../ÜB...A	227 644
Kit: G2 equipment plug, 2-pin + E	219 660
Glow lamp and series resistor (50 x) 220 V AC (spare part requirement NB, ÜB)	231 776
Glow lamp and series resistor (50 x) 120 V AC (spare part requirement NB, ÜB)	231 768
Pilot lamp 24 V AC/DC (50 x)	231 771
Line sockets, 3-pin + E grey GDMW	210 318
Line sockets, 2-pin + E grey GDMW	210 317
G 1/4 test nipple and seal ring	230 398
G 1/4 screw plug and seal ring	230 396
Double pressure switch mounting kit	213 910
Metal mounting bracket	230 288

**Compact pressure switch
for gases and air
GW A4**



**Pressure limiter
ÜB A4 and NB A4
Double pressure switch
GW A4 / GW A4**

DUNGS®

Technical data

1 mbar = 100 Pa = 0.1 kPa ≈ 10 mm WS

1 Pa = 0.01 mbar ≈ 0.1 mm WS

Type	Version	Order No. (PG 11)	Setting range [mbar]		Switching difference Δp [mbar]	
GW A4 pressure switch	GW 3 A4	172 680	0.4 - 3		≤ 0.3	
	GW 10 A4	172 690	1 - 10		≤ 0.5	
	GW 50 A4	153 600	2.5 - 50		≤ 1	
	GW 150 A4	157 050	30 - 150		≤ 3	
	GW 500 A4	157 060	100 - 500		≤ 10	
ÜB A4 pressure limiter	ÜB 50 A4	210 537	2.5 - 50		--	
	ÜB 150 A4	138 630	30 - 150		--	
	ÜB 500 A4	210 970	100 - 500		--	
NB A4 pressure limiter	NB 50 A4	210 534	2.5 - 50		--	
	NB 150 A4	210 931	30 - 150		--	
	NB 500 A4	210 971	100 - 500		--	
GW A4 min. / GW A4 max. Double pressure switch	GW 3 / 3 A4	208 929	0.4 - 3	1 - 10 2.5 - 50 30 - 150 30 - 150	≤ 0.3	≤ 0.3
	GW 3 / 10 A4	208 930	0.4 - 3		≤ 0.3	≤ 0.5
	GW 10 / 10 A4	208 931	1 - 10		≤ 0.5	≤ 0.5
	GW 10 / 50 A4	208 932	1 - 10		≤ 0.5	≤ 1
	GW 10 / 150 A4	208 933	1 - 10		≤ 0.5	≤ 3
	GW 50 / 50 A4	208 934	2.5 - 50		≤ 1	≤ 1
	GW 50 / 150 A4	208 935	2.5 - 50		≤ 1	≤ 3
	GW 150 / 150 A4	208 936	30 - 150		≤ 3	≤ 3
GW 500 / 500 A4	208 937	100 - 500	≤ 10	≤ 10		

Standard designs

Single pressure switch
GW ... A4 [AG-PG-MS9-V0]
ÜB ... A4 [AG-PG-MS9-V0]
NB ... A4 [AG-PG-MS9-V0]

Double pressure switch
GW ... A4 / GW ... A4
Min. pressure switch
[AG-PG-VS3-VS0]
Max. pressure switch
[AG-PG-MS9-V3-V0]

We reserve the right to make any changes in the interest of technical progress.



Head Offices and Factory
Karl Dungs GmbH & Co.
Siemensstraße 6-10
D-73660 Urbach, Germany
Telephone +49 (0)7181-804-0
Fax +49 (0)7181-804-166

Postal address
Karl Dungs GmbH & Co.
Postfach 12 29
D-73602 Schorndorf, Germany
e-mail info@dungs.com
Internet www.dungs.com